

### LCD Interface

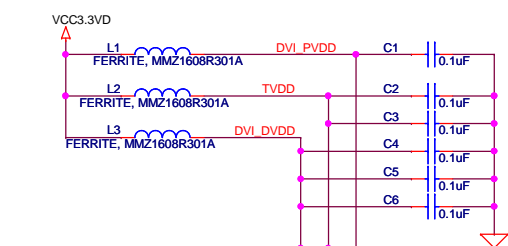

- R0 - GIO32
- R1 - GIO33
- R2 - FIELD
- R3 - YOUT3
- R4 - YOUT4
- R5 - YOUT5
- R6 - YOUT6
- R7 - YOUT7
- G0 - GIO29
- G1 - GIO30
- G2 - COUT5
- G3 - COUT6
- G4 - COUT7
- G5 - YOUT0
- G6 - YOUT1
- G7 - YOUT2
- B0 - GIO27
- B1 - GIO28
- B2 - EXTCLK
- B3 - COUT0
- B4 - COUT1
- B5 - COUT2
- B6 - COUT3
- B7 - COUT4

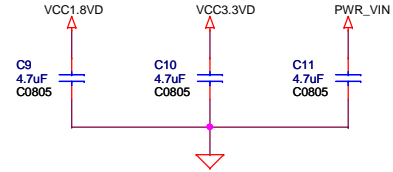
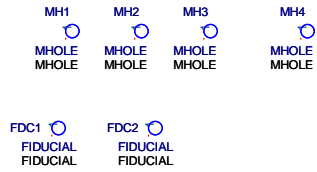
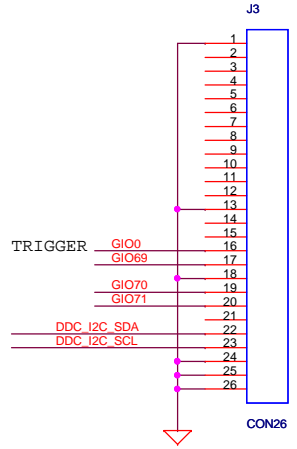
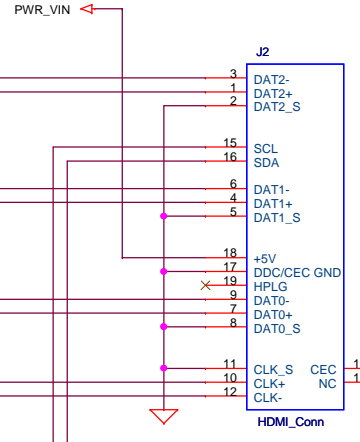
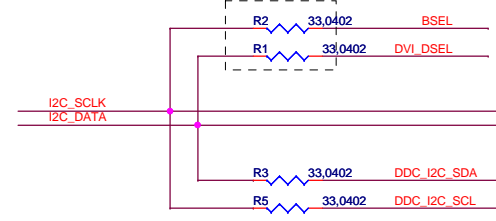
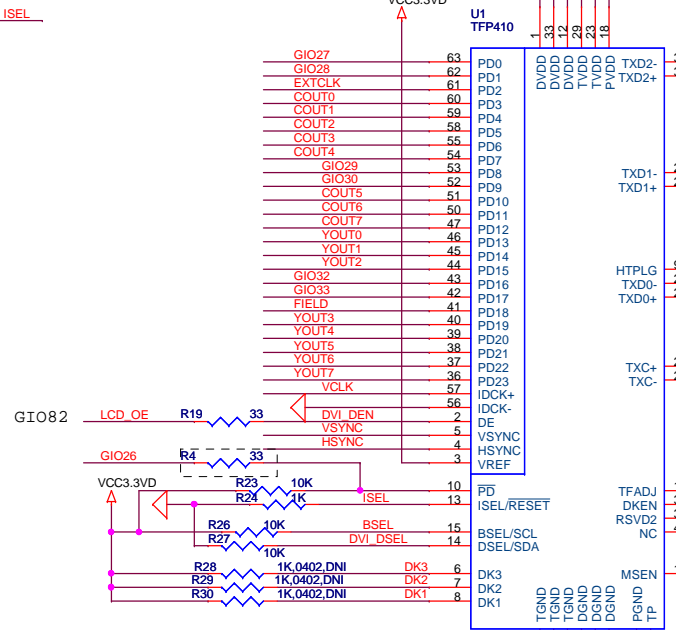

### DVI-D Interface

LEOPARD IMAGING INC		
Title: DVI BOARD		
Size B	Document Number 000	Rev 1.3
Date: Wednesday, October 07, 2009	Sheet 1 of 1	